







TECHNICAL SPECIFICATION

Model	CC-522
Display	3 Digit 0.62" 7 Segment RED / WHITE Display
Size (mm)	37 (H) x 78 (W) x 70 (D) mm
Panel Cutout	30 X 71 mm
Input	NTC Thermistor
Output	2 Relay 1st Relay For Compressor (20A Resistive load) 2nd Relay for Alarm contact (5A Resistive load)
Range	-50.0°C To 99.9°C
Power Supply	230V AC,50/60Hz,Approx 3VA
Operating Temperature	0°C To 55°C
Relative Humidity	Up to 95% RH Non Condensing

Manual Mode

If  +  Key Pressed For 10 Sec, The Relay goes in manual Defrost mode and display Show "OFF" Message. Press and hold  +  Key To turn on relay.(When LP = 0)

MECHANICAL INSTALLATION

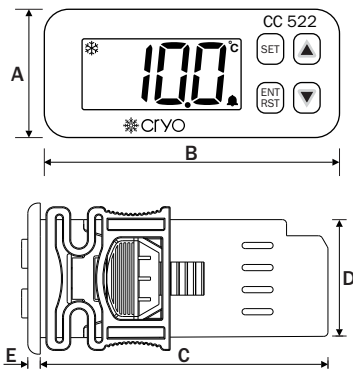



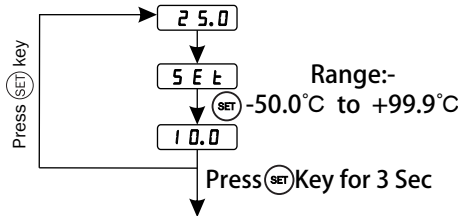

MODEL	DIMENSIONS
A	37mm
B	78mm
C	70mm
D	29mm
E	3mm

Process Value



F1	To Set Controller for Heating & Cooling mode DEFAULT SETTING : COOLING
F2	Set High Temperature (HT) Range : LT to 99.9°C DEFAULT SETTING : 99.9°C
F3	Set Low Temperature (LT) Range : -50.0°C to HT DEFAULT SETTING : -50.0°C
F4	Temperature Difference to restart compressor relay (Hysteresis) Range : 0.1° to 20.0°C DEFAULT SETTING : 3.0°C
F5	Probe Calibration (Offset) Range : -9.0° to 9.0°C DEFAULT SETTING : 0.0°C
F6	Time Delay between Compressor Relay Restart Range : 0 to 999 Minute DEFAULT SETTING : 3 MINUTE
AL	Alarm Enable/Disable 0 : Alarm Relay OFF , 1 : Alarm ON HT,LT,OPN 2 : Alarm ON HT , 3 : Alarm ON LT DEFAULT SETTING : 1
F7	To set the Alarm Delay Time (IF AL = 1,2,3) Range : 0 to 99 Minute DEFAULT SETTING : 0 Minute
F8	To set the Alarm ON Time (IF AL = 1,2,3) Range : 0 to 999 Second DEFAULT SETTING : 0 Second
r2n	To change relay polarity n0 :- Temp. above set point relay on nC :-Temp. below set point relay on DEFAULT SETTING : n0
LP	To Lock Keypad 0 : Keypad unlocked , 1 : Keypad Lock DEFAULT SETTING : 0
E1	Compressor Relay Status in case of probe failure Parameter : 0- Compressor OFF , 1- Compressor ON, 2- Compressor Perform Duty Cycle DEFAULT SETTING : 2
En	Compressor relay OFF Time (Note : E1=2) Range : 1 Minute to 99 Minute DEFAULT SETTING : 4 MINUTE
Ey	Compressor relay ON Time (Note : E1=2) Range : 1 Minute to 99 Minute DEFAULT SETTING : 10 MINUTE
dP	To Set Decimal Point Yes / No DEFAULT SETTING : YES
tU	To Set Temperature Unit °C/°F DEFAULT SETTING : °C
FSt	To restore Factory set parameter Yes / No DEFAULT SETTING : NO
PSU	To set Password 0 : Disable, 1 : Enable DEFAULT SETTING : 0 If Select 1 then Password is 39 Password is Appear before programming menu

NOTE

- Press  Key for go into the parameter
- Press  &  to change the parameter
- Press  key for exit from the program
- Press  key to reset the Alarm Relay when Alarm condition Occurs
- When Sensor is open Alarm will ON continuously (If AL1 is)
- If No key is Pressed, Menu will Automatically exit after 15 SEC. with saving.

OPn

- Sensor open or Break
- Sensor is not connected
- Temperature value goes down to -50.0 or goes up to 99.9

"OPN" have three selection of "ON", "OFF", "CYL".

- ON** = In case of sensor break, then Relay1 will continuously ON.
- OFF** = In case of sensor break, then Relay1 will continuously OFF.
- CYL** = In case of sensor break, Relay1 operate in cycle of 10 Mins ON and 4 Mins OFF.

WIRING DIAGRAM

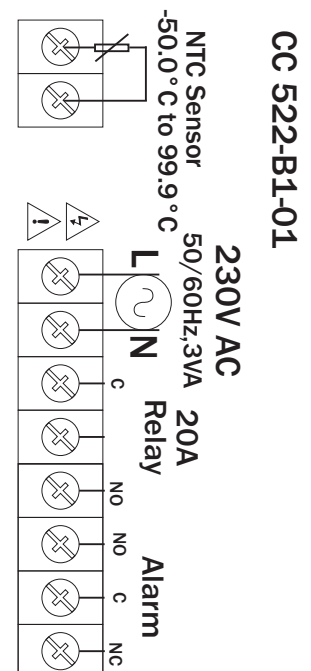

Installation Guidelines

- 1) This equipment, being built-in-type, normally becomes a part of main control panel and such in case the terminals do not remain accessible to the end user after installation and internal wiring.
- 2) Do not allow pieces of metal, wire clippings, or fine metallic fillings from installation to enter the product or else it may lead to a safety hazard that may in turn endanger life or cause electrical shock to the operator.
- 3) Circuit breaker or mains switch must be installed between power source and supply terminal to facilitate power 'ON' or 'OFF' function. However this mains switch or circuit breaker must be installed at convenient place normally accessible to the operator.
- 4) Use and store the instrument within the specified ambient temperature and humidity ranges as mentioned in this manual.

Maintenance

- 1) The equipment should be cleaned regularly to avoid blockage of ventilating parts.
- 2) Clean the equipment with a clean soft cloth. Do not use isopropyl alcohol or any other cleaning agent.
- 3) Fusible resistor must not be replaced by operator.

WIRING DIAGRAM

CC 522-B1-01

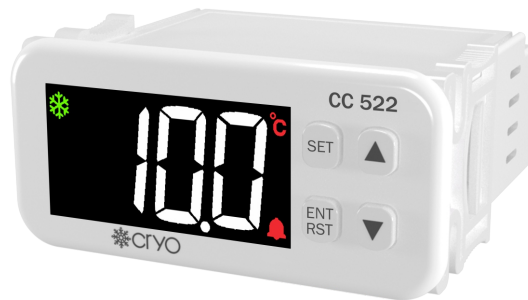
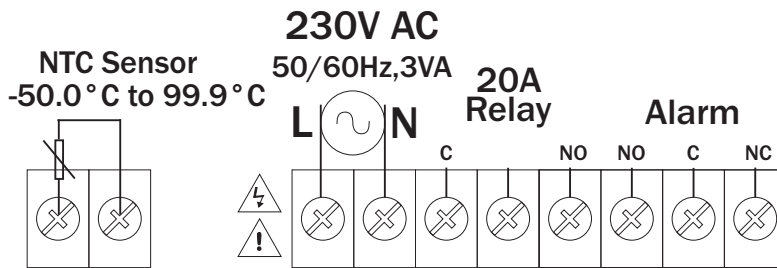

OPERATING MANUAL COOLING CONTROLLER

Factory Set Data		
Parameter	DP = Yes	DP = No
Hysteresis	3.0	3
Time Delay	3 min	3 min
Alarm Delay Time	0 Min	0 Min
Alarm ON Time	0 Sec	0 Sec
Set Lower Limit	-50.0°C	-50°C
Set Higher Limit	99.9°C	99°C
Offset	0.0°C	0°C
Open	Duty Cycle	Duty Cycle

- Setpoint, DP selection and Temperature will not change, When you restore the factory data.

Mechanical Installation Guideline

- 1) Prepare the panel cutout with proper dimensions as show above.
- 2) Fit the unit into the panel with the help of clamp given.
- 3) The equipment in its installed state must not come in close proximity to any heating source, caustic vapors, oils steam, or other unwanted process by products.
- 4) Use the specified size of crimp terminal (M3.5 screws) to wire the terminal block. Tightening the screws on the terminal block using the tightening torque of the range of 1.2 N.m.
- 5) Do not connect anything to unused terminals.

Safety Precautions

All safety related codifications, symbols and instructions that appear in this operating manual or on the equipment must be strictly followed to ensure the safety of the operating personnel as well as the instrument.

If all the equipment is not handled in a manner specified by the manufacturer, it might impair the protection provided by the equipment .

=> Read complete instructions prior to installation and operation of the unit.

⚠ WARNING : Risk of electric shock.

Warning Guidelines

- 1) To prevent the risk of electric shock power supply to the equipment must be kept OFF while doing the wiring arrangement. Do not touch the terminals while power is being supplied.
- 2) To reduce electro magnetic interference, use wire with adequate rating and twists of the same of equal size shall be made with shortest connection.
- 3) Cable used for connection to power source, must have a cross section of 1mm or greater. These wires should have insulations capacity made of at least 1.5kV.
- 4) When extending the thermocouple lead wires, always use thermocouple compensation wires for wiring for the RTD type, use a wiring material with a small lead resistance (5Ω max per line) and no resistance differentials among three wires should be present.
- 5) A better anti-noise effect can be expected by using standard power supply cable for the instrument.



Temperature & Humidity Controllers

Designed for Refrigeration & HVAC

A wide range of controllers for managing various refrigeration applications.

A brand by **MULTISPAN**

www.multispandinia.com

Product improvement and upgrade is a constant procedure.
So for more updated operating information and support,
Please contact our helpline : +91-9978991483/81 or
Email at service@multispandinia.com Ver: 2208